

# USER MANUAL



## **NitroFlow<sup>®</sup> Lab** **NITROGEN GENERATOR**

Parker Filtration & Separation B.V.  
PO Box 258  
4870 AG - Etten-Leur  
The Netherlands  
Tel: +31 (0)76-508 53 00  
Fax: +31 (0)76-508 53 33  
E-mail: [pfsinfo@parker.com](mailto:pfsinfo@parker.com)  
[www.parker.com/pfs](http://www.parker.com/pfs)



© 2006 Parker Filtration & Separation B.V.

All rights reserved

No part of this publication may be reproduced and/or publicized by being printed, photocopied, placed on microfilm or in any other manner without the prior written permission of Parker Filtration & Separation B.V.

Parker Filtration & Separation B.V. retains the right to make changes in parts at any point without first or directly notifying the customer. The contents of this manual can also be changed without prior warning.









This manual is valid for the NitroFlow<sup>®</sup> Lab in its standard version. Parker Filtration & Separation B.V. can therefore not be held liable for specifications of the delivered system that may deviate from the standard version.

For information concerning adjustments, maintenance or repairs not contained in this manual, please contact Parker Filtration & Separation B.V.

This manual has been prepared with all possible care, but Parker Filtration & Separation B.V. cannot accept responsibility for possible errors in this document or for the consequences thereof.

---

<b>USER MANUAL</b> .....	<b>1</b>
<b>1 INTRODUCTION</b> .....	<b>5</b>
1.1 General .....	5
1.2 Pictograms .....	6
1.3 Identification and service .....	7
1.4 Certificates .....	7
1.5 Use in accordance with purpose .....	8
1.6 User instructions .....	8
1.7 Liability .....	8
<b>2 HEALTH, SAFETY AND ENVIRONMENTAL ASPECTS</b> .....	<b>9</b>
2.1 General .....	9
2.2 Nitrogen and oxygen .....	9
2.3 Electricity.....	10
2.4 Safety precautions .....	10
2.5 Environmental aspects.....	11
<b>3 DESCRIPTION OF THE APPLIANCE</b> .....	<b>12</b>
3.1 General .....	12
3.2 Separation principle .....	12
3.3 Parts .....	13
3.4 Process diagram .....	14
3.5 Process scheme .....	15
<b>4 TECHNICAL SPECIFICATIONS</b> .....	<b>16</b>
4.1 General .....	16
4.2 Capacity data .....	19
4.3 Maintenance kit.....	19
<b>5 INSTALLATION</b> .....	<b>20</b>
5.1 Transport.....	20
5.2 Define location .....	20
5.3 Unpack and check equipment.....	21
5.4 Connect nitrogen consumer .....	21
5.5 Connecting power .....	21
5.6 Connect input and output signals.....	22
<b>6 OPERATION OF THE CONTROL SYSTEM</b> .....	<b>24</b>
6.1 Menu structure .....	24

6.2	Main screen .....	24
6.3	Settings menu  .....	26
6.3.1	Log on menu  .....	27
6.3.2	Alarm settings menu  .....	28
6.3.3	Pressure switch menu  .....	30
6.3.4	Options menu  .....	31
6.3.5	Local settings menu  .....	32
6.3.6	Maintenance menu  .....	33
6.3.7	Data logging menu  .....	36
<b>7</b>	<b>OPERATION.....</b>	<b>38</b>
7.1	Commisioning NitroFlow <sup>®</sup> Lab .....	38
7.2	Start NitroFlow <sup>®</sup> Lab .....	39
7.3	Adjusting the purity .....	39
7.4	Control of the outlet pressure.....	40
7.5	Stop NitroFlow <sup>®</sup> Lab.....	41
<b>8</b>	<b>TROUBLESHOOTING.....</b>	<b>42</b>
8.1	Error list.....	42
8.2	Alarm messages  .....	43
<b>9</b>	<b>MAINTENANCE.....</b>	<b>45</b>
9.1	Maintenance scheme.....	45
9.2	Replace inlet filter element.....	45
9.3	Replace oxygen sensor .....	47
9.4	Calibrate oxygen sensor .....	47
9.5	Replace compressor .....	48
9.6	Software updates .....	50
<b>10</b>	<b>ELECTRICAL SCHEME .....</b>	<b>52</b>
<b>11</b>	<b>INDEX .....</b>	<b>53</b>

# 1 Introduction

## 1.1 General

The *NitroFlow*<sup>®</sup> Lab is a product of Parker Filtration & Separation B.V. This manual forms an integral part of the product. The manual describes the installation, daily operation, maintenance and troubleshooting.

### **Content**

Read the manual carefully before you start with the NitroFlow<sup>®</sup> Lab. These instructions must be thoroughly understood before installing and operating this product. Failure to operate this product in accordance with the instructions set forth in this manual and by other safety governing bodies will void the safety certification of this product. If you have any questions or concerns, please call your local representative or the technical services department:

Europe +(44) 1622 7233 00, USA +(1) 800 343 4048

### **Condition of change**

No changes may be made to the NitroFlow<sup>®</sup> Lab as supplied, without explicit prior written permission by Parker Filtration & Separation B.V. Non-conformance to this rule, as well as any consequential damage, loss and costs are the responsibility of the owner and the user.

### **Information**

All information in this manual, including additional drawings and technical descriptions, remains the property of Parker Filtration & Separation B.V. and may not be used (otherwise than for the use of this product), copied, multiplied or published to or for a third party without explicit prior written permission by Parker Filtration & Separation B.V.

## 1.2 Pictograms

In this manual and on the generator, the following pictograms are used:



### **Warning**

**A warning shows a hazard that can cause death or serious injury. Follow the instructions.**



### **Caution**

**A caution shows a danger that can cause damage to the equipment. Follow the instructions.**



### **Electricity**

**High voltage: danger of electric shock.**



### **Warning**

**Risk for death due to suffocation.**



### **Risk of fire**

**Oxygen-enriched air leads to an increased risk of fire in the event of contact with inflammable products.**



### **High-pressure risk**

**Follow the instructions with respect to compressed gasses.**



### **Environment**

**Instructions with respect to the environment.**

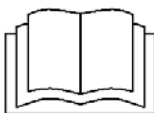

**Read instructions in the manual.**

### 1.3 Identification and service

The identification plate is located on the back of the NitroFlow® Lab. The identification plate shows the characteristics of the NitroFlow® Lab.

For service and technical assistance, please contact:

**PARKER FILTRATION & SEPARATION, MAIDSTONE**  
 Hermitage Court, Hermitage Lane,  
 Maidstone, Kent ME16 9NT  
 Engeland  
 Tel: (+44) 1622 7233 00  
 Fax: (+44) 1622 7287 03



Fig. 1-1: Identification plate

For North America:  
**PARKER HANNIFIN CORPORATION**  
 242 Neck Road  
 Haverhill, MA01835  
 USA  
 Tel: (+1) 978 67 47 400  
 Fax: (+1) 978 37 47 070

### 1.4 Certificates

The NitroFlow® Lab meets the following requirements:

Subject	Applicable standard
Electromagnetic compatibility (EMC)	NEN-EN-IEC 61000-6-3:2001 NEN-EN-IEC 61000-6-1:2001 EN 61326(1997) + A1(1998) + A2(2001) + A3(2003), class A EN 61000-3-2(2000) EN 61000-3-3(1995) + A1(2001)
Electrical safety	NEN EN 60204-1:2001
Safety for laboratory use	UL 61010A-1 (1 <sup>st</sup> Ed) CAN/CSA-C22.2 No. 61010-1-04 IEC 61010-1:2001

Safety of pressure equipment	Sound engineering practice
Installation	IEC 61010-1 Cat II
Quality assurance	ISO 9001:2000
Environmental care	ISO 14001:2004

## **1.5 Use in accordance with purpose**

The NitroFlow<sup>®</sup> Lab is intended to produce nitrogen out of normal ambient air. The system is based on gas separation membranes. Each different or further use will not be in conformity with the purpose. Parker Filtration & Separation B.V. will not accept any liability for improper use.

The NitroFlow<sup>®</sup> Lab is in compliance with the prevailing directives and standards. Only use this NitroFlow<sup>®</sup> Lab in a technically perfect condition, in conformity with the purpose as described above.

## **1.6 User instructions**

Only well-trained personnel are allowed to work on the NitroFlow<sup>®</sup> Lab. The user must be aware of hazards related to operating the NitroFlow<sup>®</sup> Lab and processes connected to the NitroFlow<sup>®</sup> Lab. The user is responsible for the safety of the personnel. All personnel working on the NitroFlow<sup>®</sup> Lab must have free access to the applicable manuals.

## **1.7 Liability**

Parker Filtration & Separation B.V. will not accept any liability if:

- The instructions in this manual are ignored.
- Replacement parts are used which are not approved by the manufacturer.
- The NitroFlow<sup>®</sup> Lab is operated incorrectly.
- The system is fed with other gasses than air.
- The NitroFlow<sup>®</sup> Lab is modified without notification and authorization of Parker.
- Maintenance and repair are not carried out according to the instructions.

## 2 Health, safety and environmental aspects

### 2.1 General

Correct use of the NitroFlow<sup>®</sup> Lab nitrogen generator is important for your personal safety and for trouble-free functioning of the NitroFlow<sup>®</sup> Lab. Incorrect use can cause damage to the NitroFlow<sup>®</sup> Lab or can lead to incorrect gas supply.



#### Warning

- Read this manual before you start the installation and putting into operation of the NitroFlow<sup>®</sup> Lab. Prevent accidents and damage to the NitroFlow<sup>®</sup> Lab.
- Contact your supplier if you detect a problem that you cannot solve with this manual.
- Use the NitroFlow<sup>®</sup> Lab in accordance with its purpose. Refer to §1.5.
- Only service-engineers, qualified to work on electric and pneumatic equipment, are allowed to do the installation, maintenance and repairs. Unqualified people are not allowed to repair the equipment. Refer to §1.6. Lift the NitroFlow<sup>®</sup> Lab with a forklift. Follow the legislation and instructions for operating the forklift.
- Do not tamper or experiment with the equipment. Do not exceed the technical specifications for the NitroFlow<sup>®</sup> Lab. Refer to chapter 4.

### 2.2 Nitrogen and oxygen

The NitroFlow<sup>®</sup> Lab generates nitrogen as a product. Oxygen enriched air is released as waste.



#### Warning

- Nitrogen can cause suffocation!
- Oxygen-enriched air leads to increased risk of fire in the event of contact with flammable products. Make sure that there is adequate ventilation at all times!



- The NitroFlow<sup>®</sup> Lab is not designed for installation in an Exx-classified area.
- Do not install the NitroFlow<sup>®</sup> Lab in an area where explosive mixtures may occur.

## 2.3 Electricity



### Warning

- Only service-engineers, qualified to work on electrical equipment, are allowed to do the installation, maintenance and repairs.
- Disconnect the main power supply before you do the maintenance or repair.
- If a service-engineer has to work on the NitroFlow<sup>®</sup> Lab while the electric power it is connected, the service-engineer must be very careful with respect to the electric hazards.

## 2.4 Safety precautions



### Warning

- Make sure that the ventilation rate is sufficient in the room where the enriched oxygen is ventilated, or lead the enriched air outside. Keep the ambient temperature between 10 and 35 °C.
- Install the peripheral equipment, piping and nitrogen storage vessels according to standard procedures. Parker Filtration & Separation B.V. cannot take responsibility for this.
- Do regular maintenance to the NitroFlow<sup>®</sup> Lab, to ensure proper and safe operation. Refer to chapter 8.
- Make sure that instructions concerning health and safety are compliant with the local legislation and regulations.

## 2.5 Environmental aspects

The use and maintenance of the NitroFlow<sup>®</sup> Lab does not include environmental dangers. Most parts are made of metal and can be disposed in the regular way. The packaging of the NitroFlow<sup>®</sup> Lab is 100% recyclable. Optimal sizing of buffer tanks and setting of the pressure switch will result in minimal energy consumption. The lower the delivery pressure, the longer the lifetime of the system.

According to EC-regulations electrical systems have to be disassembled and recycled at the end of their life. Parker Filtration & Separation B.V. can support you in this.



**Make sure that instructions concerning health, safety and environment are compliant with the local legislation and regulations.**

### 3 Description of the appliance

#### 3.1 General

The NitroFlow<sup>®</sup> Lab separates compressed air produced by an on-board compressor into nitrogen and an oxygen enriched air stream. The separation system is based on membranes.

#### 3.2 Separation principle

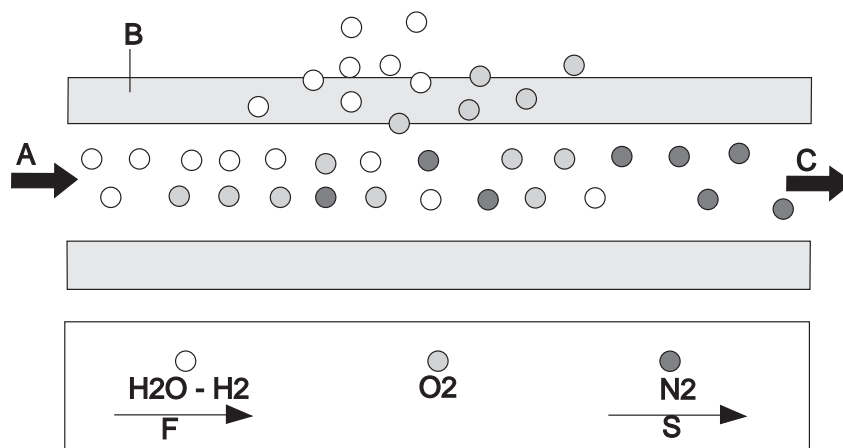

Fig. 3-1: Separation principle

- |   |                       |   |                 |
|---|-----------------------|---|-----------------|
| A | Pressurized air inlet | F | Fast permeation |
| B | Hollow fibre membrane | S | Slow permeation |
| C | Nitrogen outlet       |   |                 |

Ambient air contains nitrogen (78.1%), oxygen (20.9%), argon (1%), carbon dioxide, water vapor and traces of other inert gasses. Pressurized air (A) is led through hollow fibre membranes(B). The various air components diffuse through the porous wall of the membranes.

The diffusion rate differs for the various gasses:

- Oxygen and water vapor have a high diffusion rate and diffuse rapidly through the membrane wall.
- Nitrogen has a low diffusion rate and diffuses slowly through the membrane wall.

Pressurized nitrogen enriched air is released at the outlet of the membranes (E) which can be stored in a nitrogen storage vessel.

### 3.3 Parts

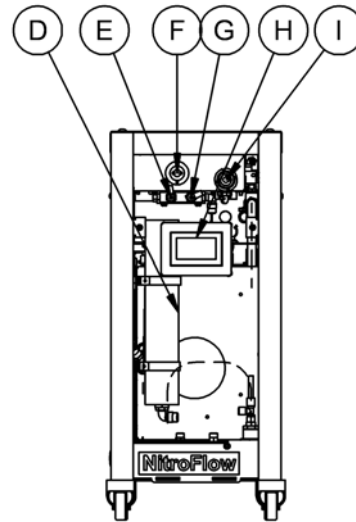
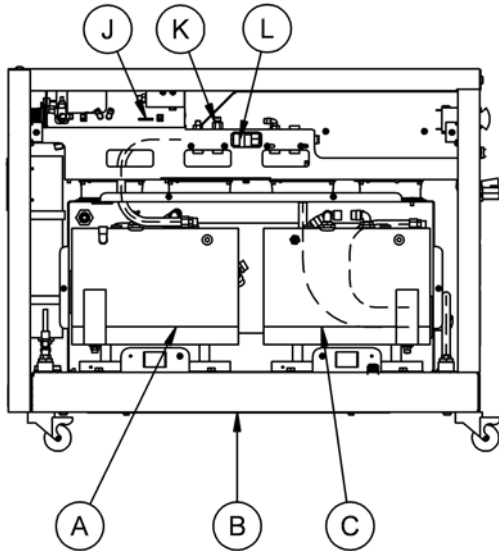

- A Nitrogen compressor
- B Hollow fiber membrane and heat exchanger (M)
- C Air compressor
  
- J SD-card
- K Pressure relief valve (PSV)
- L Non-return valve (V1)

- D Inlet carbon adsorber (C)
- E Purity adjustment valve(FCV)
- F Oxygen sensor
- G Sample flow control valve (do not adjust) (FCV)
- H Touch screen display
- I Pressure control valve (PCV)

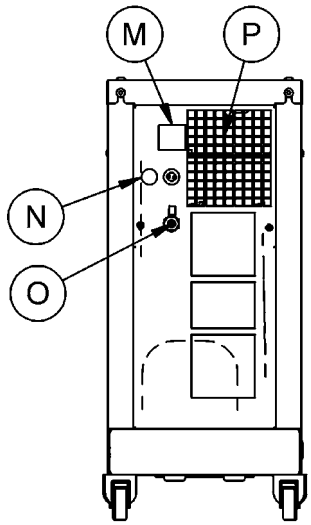

- M Main switch/ circuit breaker
- N Electrical feed cable
- O Product outlet /ball valve
- P Ventilation outlet (keep clear)

### 3.4 Process diagram

The NitroFlow<sup>®</sup> Lab can be connected directly to the nitrogen consumer (Fig. 3-3) or to a buffer vessel (Fig. 3-4).

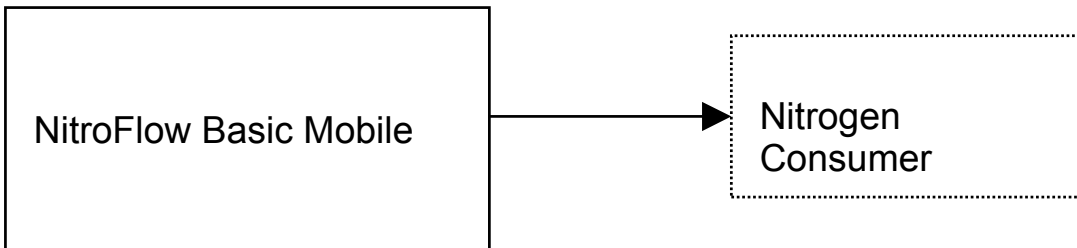

Fig. 3-3

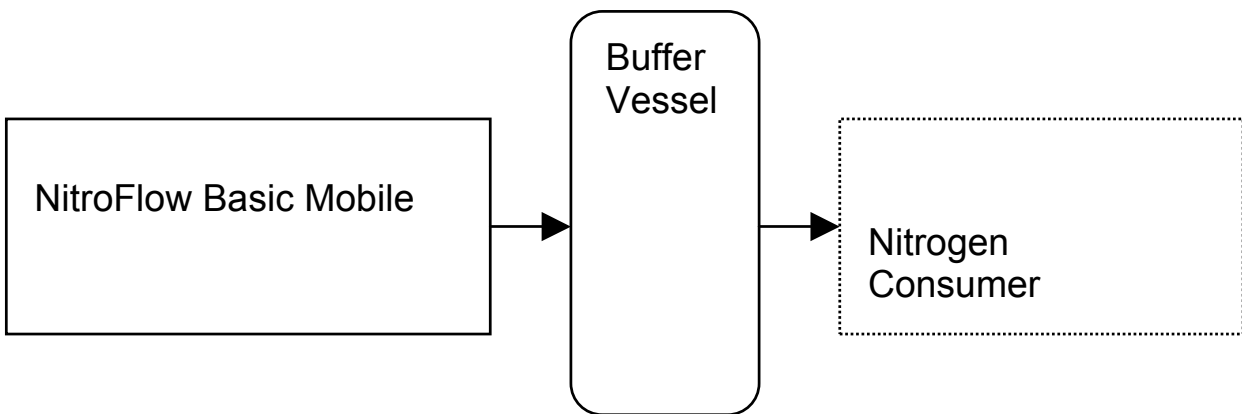
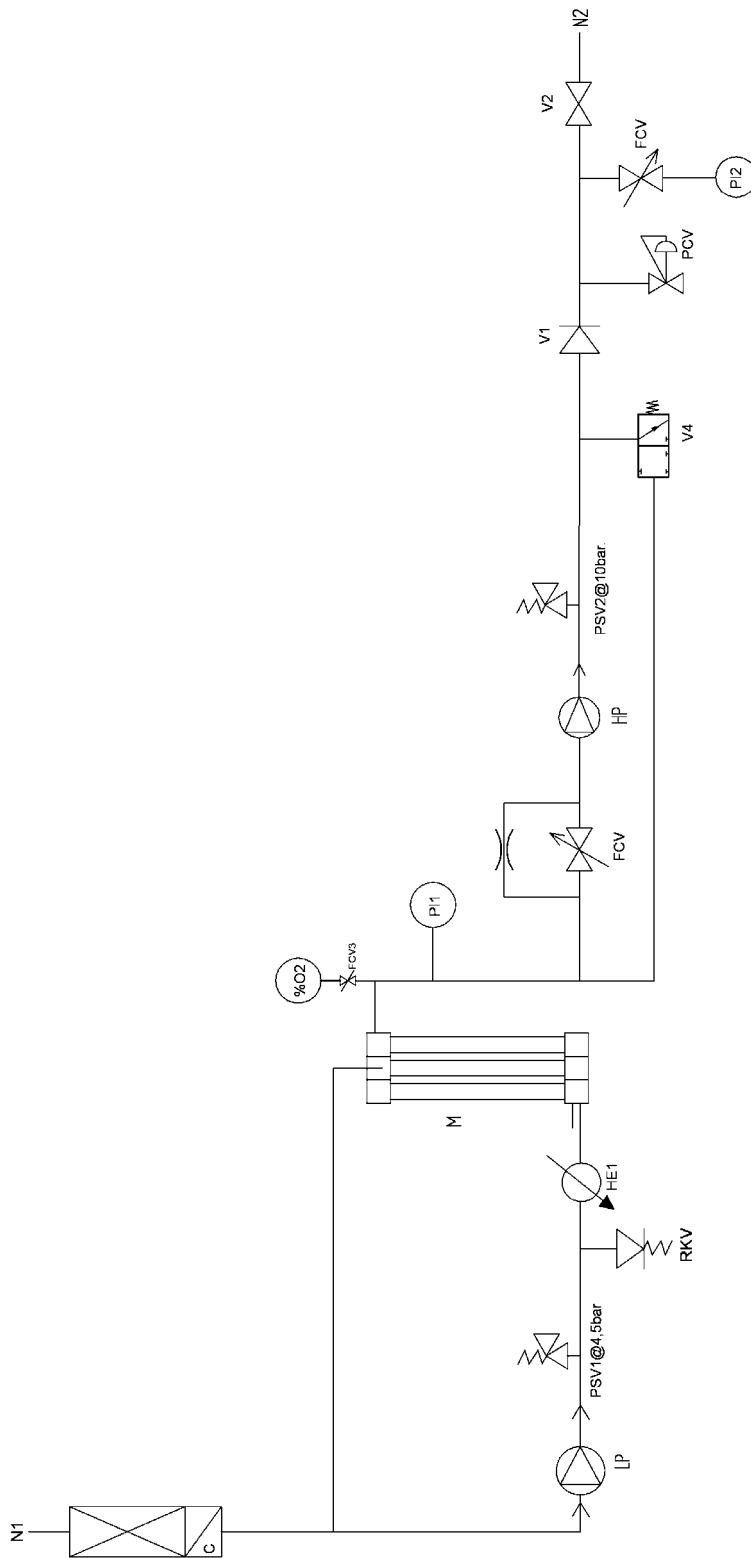

Fig: 3-4

### 3.5 Process scheme











N1	Air inlet
N2	Nitrogen outlet
C	Inlet carbon adsorber
LP	Air compressor
RKV	Start up valve
M	Gas separation membrane
PI1	Membrane pressure indicator
FCV	Flow control valve
HP	Nitrogen compressor
PCV	Nitrogen pressure relief valve
PI2	Nitrogen pressure indicator
V1	Non return valve
N2	Nitrogen outlet
V2	Ball valve
V4	Depressurisation valve
PSV1/2	Pressure relief valves









## 4 Technical specifications

### 4.1 General

<b>Delivery pressure</b>	
Maximum delivery pressure	8 bar(g)/116 psig
<b>Ambient conditions</b>	
Temperature	10 to 35 °C / 50 to 95 °F
Air quality	Normal clean ambient air, relative humidity < 90%
Max. ambient relative humidity	<80 % to 31°C, 50% at 40°C
Noise level	< 65 dB(A) @ 1 meter/3 ft
Heat dissipation	1000 W (@50 Hz), 1200 W (@60 Hz) 3850 (50Hz)/4625 (60 Hz) BTU/hr
<b>Dimensions and connections</b>	
Dimensions (H x W x D) [mm]	700 x 900 x 310
Dimensions (H x W x D) [inch]	27.6 x 35.4 x 12.2
Net weight	92.5 kg / 204 lbs
Connections	outlet: G ¼ " / ¼" NPT
<b>Electrical data</b>	
Voltage/frequency <sup>1</sup>	100Vac/50Hz, 100Vac/60Hz, 120Vac/60Hz, 230Vac/50Hz
Power consumption	1400 W
Plug/receptacle	230V/50Hz can be mounted locally as to local requirements  115V/60Hz: 20A/125 VAC; NEMA 5-20 straight blade

<sup>1</sup> Mains supply voltage fluctuations not to exceed +/- 10% of nominal voltage.

Default software settings		
Menu	What	Default setting
 Logs	Delay-time	180 sec
 Local settings	Language	English
 Local settings	Pressure	Bar
 Local settings	Flow	LPM
 Local settings	Purity	%O2
 Alarm settings	O2 high	Active: No Stop: 0 Level: 5 Delay: 30
 Alarm settings	O2 low	Active: No Stop: 0 Level: 0.0 Delay: 30
 Alarm settings	Pin high	Active: No Stop: 0 Level: 13 Delay: 30
 Alarm settings	Pin low	Active: No Stop: 0 Level: 2 Delay: 30

 Alarm settings	Pout high	Active: No Stop: 0 Level: 10 Delay: 30
 Alarm settings	Pout low	Active: No Stop: 0 Level: 2 Delay: 30
 Pressure switch	P-switch	No
 Pressure switch	Unit on	2.0
 Pressure switch	Unit off	7.0
 Options	Auto restart	No
 Options	Remote	No
 Options	Pincode	No
 Options	Show Flow	No

Parts	
NitroFlow <sup>®</sup> Lab	1x NitroFlow <sup>®</sup> Lab 1x Manual

Vac/Hz	Part numbers NitroFlow <sup>®</sup> Lab
100/50	159.003869
100/60	159.003870
120/60	159.003868
230/50	159.003848

## 4.2 Capacity data

Generator	Nominal production capacity Nlpm*								
	99.9	99.7	99.5	99	98	97	96	95	93
NitroFlow Lab	7.6	12	13	18	23	26	30	32	38

\*Capacity at nominal conditions:

- Ambient temperature: 20 °C /68 °F
- Ambient pressure: 1013 mbar(a).

## 4.3 Maintenance parts

Part	Part number
Maintenance kit: 1x Carbon adsorber	159.003754
Oxygen sensor	159.002284
Battery on printed circuit board	159.004270
Fuse on printed circuit board (T1,25A, 250V, 5x20mm)	159004271
Air compressor LP/LP ( <b>230V/50Hz</b> )	159.003314
Air compressor LP/LP ( <b>115V/60Hz</b> )	159.003368
Nitrogen compressor LP/HP ( <b>230V/50Hz</b> )	159.003313
Nitrogen compressor LP/HP ( <b>115V/60Hz</b> )	159.003367

## 5 Installation

Follow the paragraphs in this chapter to install the NitroFlow<sup>®</sup> Lab.

### 5.1 Transport



#### Warning

- Transport the NitroFlow<sup>®</sup> Lab upright.
- Put the NitroFlow<sup>®</sup> Lab in the original box to transport the NitroFlow<sup>®</sup> Lab over longer distances.
- Lift the NitroFlow<sup>®</sup> Lab with a forklift.
- For qualifications of personnel, refer to §2.1.

### 5.2 Define location



#### IMPORTANT

- The NitroFlow<sup>®</sup> Lab contains compressors that generate heat; for optimal performance and lifetime it is necessary that cooling air can be vented without resistance. A minimum clearance distance from walls or other objects of at least 50 cm/ 20 inches on all sides (back, left, right and top) is a necessity; also efficient local ventilation at the ventilation outlet is highly recommended especially when the device is installed under a bench

Install the NitroFlow<sup>®</sup> Lab on a fixed location. The location must meet the following requirements:

- Minimum clearance of 50 cm on all sides (back, left, right and top) as to facilitate heat removal
- Indoors
- Dry
- No continuous direct irradiation by sunlight
- Away from heat sources
- Properly ventilated room.
- Easy accessibly for operating and service

## 5.3 Unpack and check equipment

- Open the packaging per instructions on the crate.
- Make sure that all components are delivered. Refer to § 4.1.

## 5.4 Connect nitrogen consumer



### Warning

- Do not connect the power at this time.
- Make sure that the inlet and outlet tubes are free of dust, particles, metal parts and curls, liquids and grease before you connect the NitroFlow<sup>®</sup> Lab.

Connect the product outlet to the application.

## 5.5 Connecting power

1. Connect the mains plug to a suitable wall socket with earth connection
2. The control system has in- and output contacts for remote control and alarm signaling (refer to §5.6).



### Warning

**The main supply line voltage must be within 10% of nominal rated voltage for the generator. In case of larger variations the NitroFlow Lab will stop; continued use under these circumstances will inevitably lead to motor damage.**



Clamp	Function	Input/output signals
ID1	Remote start/stop	<i>Digital input</i> Nominal input current: 10 mA Voltage: internal power supply
UA1	Oxygen concentration	<i>Analogue output</i> Input impedance to reach 0 mA – 20 mA: 200 Ohm
UA2	Outlet pressure	
K5	Start stop signal to external booster	<i>Relay</i> Switch voltage: 48V AC/DC Switch current: 1A AC/DC
K6	General alarm (nc/no)	
K7	General alarm (nc/no) (=K6)	
K8	Spare	

## 6 Operation of the control system

### 6.1 Menu structure

The menu structure of the control system is built up as shown below. One can always go back to a higher level in the menu by pushing the -button.

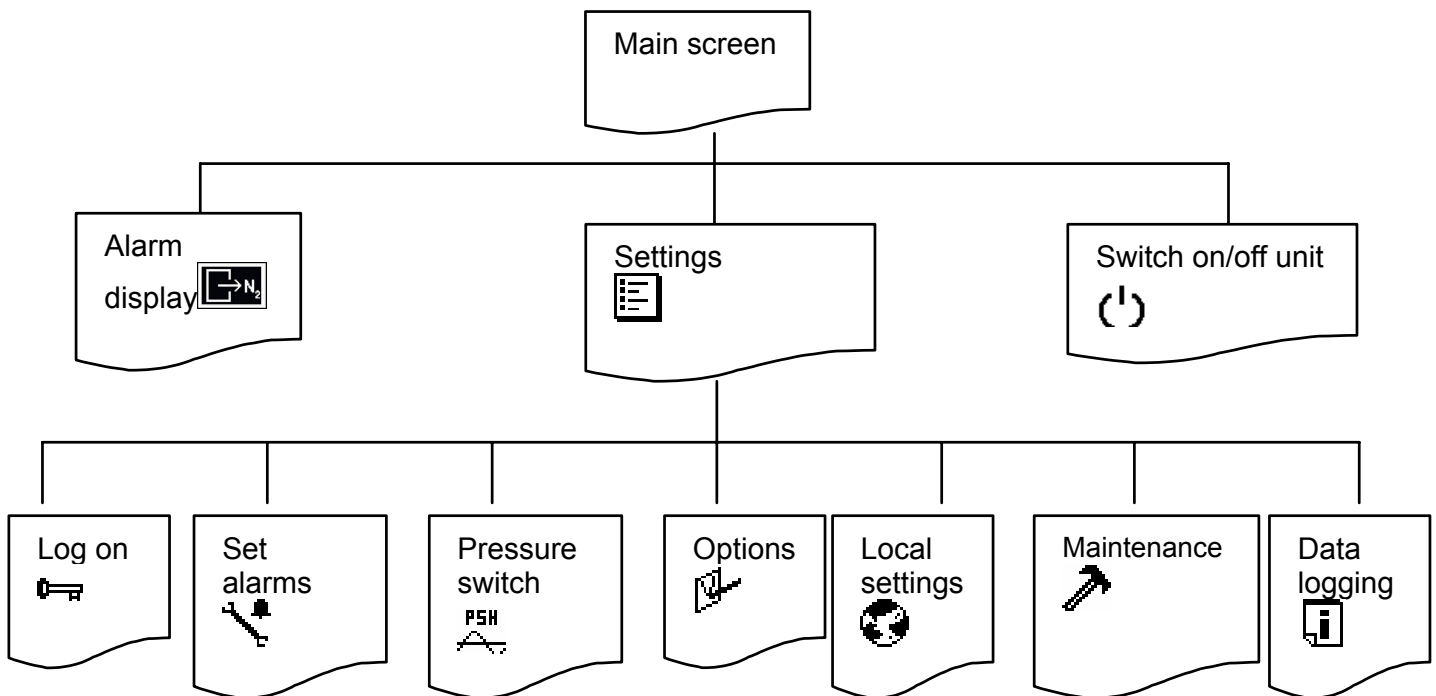



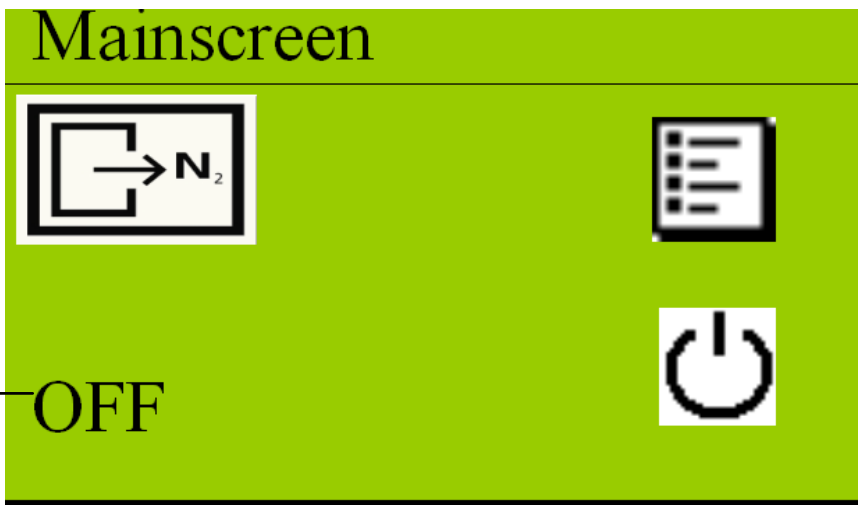

### 6.2 Main screen

**Access:** This is the start-up screen that automatically appears when the generator is switched on.

**Function:** Gives access to the different menus.



Symbol/data	Information/result
	When flashing there is an alarm; touch the symbol and the current alarm will be shown.
Status of unit (A)	Can be OFF/RUN/STAND-BY/ALARM/P-RELIEF
	Menu button, touch to go to settings menu
	Switch ON/OFF button, generator will turn ON or OFF

To turn the unit on, touch the switch -button. The status will switch to P-RELIEF. The compressors will start three minutes (180 seconds) after the unit has been switched on. The delay time countdown time is shown next to the text P-RELIEF (see below).

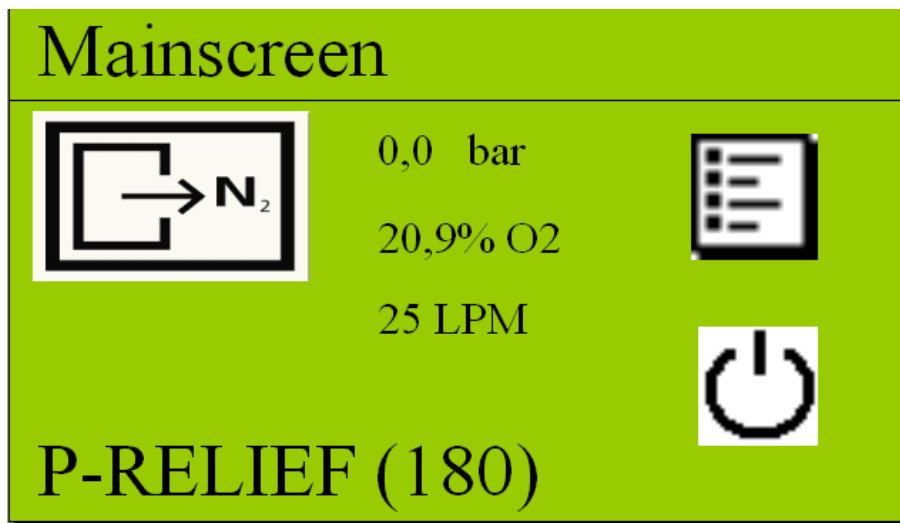

When the unit is switched on the controller will show:









- Actual outlet pressure
- Actual oxygen or nitrogen level
- Flow indication (when selected, refer to §6.3.4)

### 6.3 Settings menu

**Access:** Touch settings menu button  in the main screen (refer to §6.2)

**Function:** Access to different menus



Symbol	Menu
	Access to <b>log on menu</b> (refer to §6.3.1)
	Access to <b>alarm settings menu</b> (refer to §6.3.2)
	Access to <b>pressure switch menu</b> (refer to § 6.3.3)
	Access to <b>options menu</b> (refer to § 6.3.4)
	Access to <b>local settings menu</b> (refer to § 6.3.5)
	Access to <b>maintenance menu</b> (refer to § 6.3.6)
	Access to <b>data logging menu</b> (refer to § 6.3.7)
	Returning to previous menu

### 6.3.1 Log on menu

**Access:** Touch log on menu button  in settings screen (refer to §6.3)

**ATTENTION: When you start-up the system for a first time you do not need to enter a PIN CODE**

**Function:** Protect the settings in the system with a (personal) pin code.

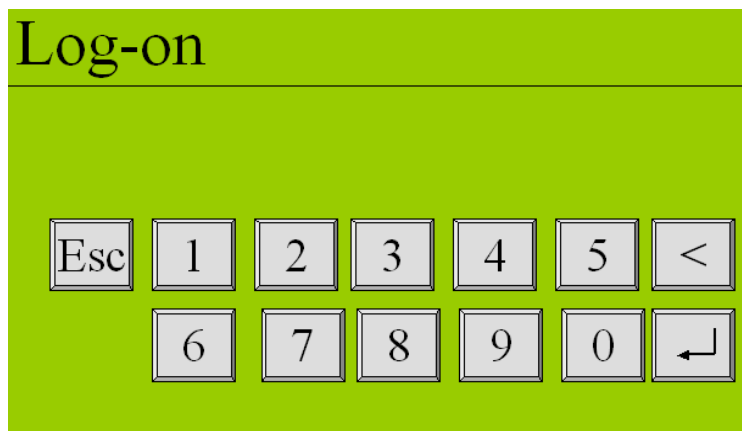

In the log on menu:

- Enter the default pin code (**1234**) after selecting PINCODE YES under the options menu (refer to §6.3.4).
- Change the default pin code to a personal pin code of 4 digits (refer to §6.3.4)
- Return to default factory settings by entering pin code **7833** (refer to §4.1)
- In case you lost your pin code, please contact your supplier

**Caution:**

**When returning to factory settings, the alarms, p-switch, options and settings must be reset. Also the log on pincode is back to default value 1234**

### 6.3.2 Alarm settings menu

**Access:** Touch alarm settings menu button  in settings screen (see § 6.3.2)

**Function:** Set different alarms

In the alarm settings menu it is possible to set 6 different alarms.

Screen	Alarm	Explanation
1/6	O2 high	oxygen level too high
2/6	O2 low	oxygen level too low
3/6	Pres. Inlet high	inlet pressure too high
4/6	Pres. Inlet high	inlet pressure too high
5/6	Pres. Outlet high	outlet pressure too high
6/6	Pres. Outlet low	outlet pressure too low

1. To activate an alarm touch button A. When the button is touched you can select the options YES, AUTO RESET or NO by pressing the arrow keys



**Default all alarms are set to NO, which means they are not activated; activating the alarms or not is the choice of the user; alarms do not influence the output and purity.**

2. When you select YES or AUTO RESET, the rest of the alarm parameters that need to be set will pop-up automatically (see screen below).

O2 high
%O2
1/6

A ←  Active

Stop

Level

Delay

Yes

No

5.0

10

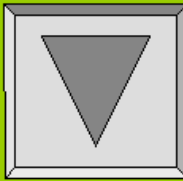
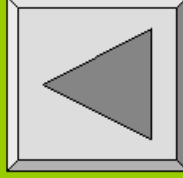
Button	Selection	Result
Active	No	Alarm function for this parameter is not active
Active	Yes	Alarm function for this parameter is active; alarm messages must be reset manually
Active	Auto reset	Alarm function for this parameter is active; When alarm level is not exceeded any longer before manual reset, the alarm will reset itself
Stop	Yes	Generator will switch off in case alarm level is exceeded
Stop	No	An alarm signal will be given but generator will continue to run in case alarm level is exceeded
Level	0-16% O <sub>2</sub> 100 – 84% N <sub>2</sub>	For screen 1/6 and 2/6: this is the oxygen- or nitrogen level* at which the alarm is set.
Level	0-13 BAR* 0-188.5 PSI*	For screen 3/6 and 4/6. This is the pressure level at which the alarm is set
Level	0-10 BAR* 0-145 PSI*	For screen 5/6 and 6/6. This is the pressure level at which the alarm will appear.
Delay	0-300 sec	Delay time in seconds between the moment that the alarm level has been exceeded and signaling; this feature prevents false alarms in case of short spikes

\*see also local settings -menu



**ATTENTION:**

It is impossible to set O<sub>2</sub> low at a higher level than O<sub>2</sub> high. The setting of O<sub>2</sub>-low is limited once O<sub>2</sub>-high has been set. Therefore first set O<sub>2</sub> high level before setting the O<sub>2</sub> low level.

### 6.3.3 Pressure switch menu

**Access:** Touch pressure switch menu button  in settings screen (refer to § 6.3)

**Function:** Set the pressure switch

In the pressure switch menu the levels at which outlet pressure the generator will switch on and off, can be set. To change the settings, touch the button in front of the text.

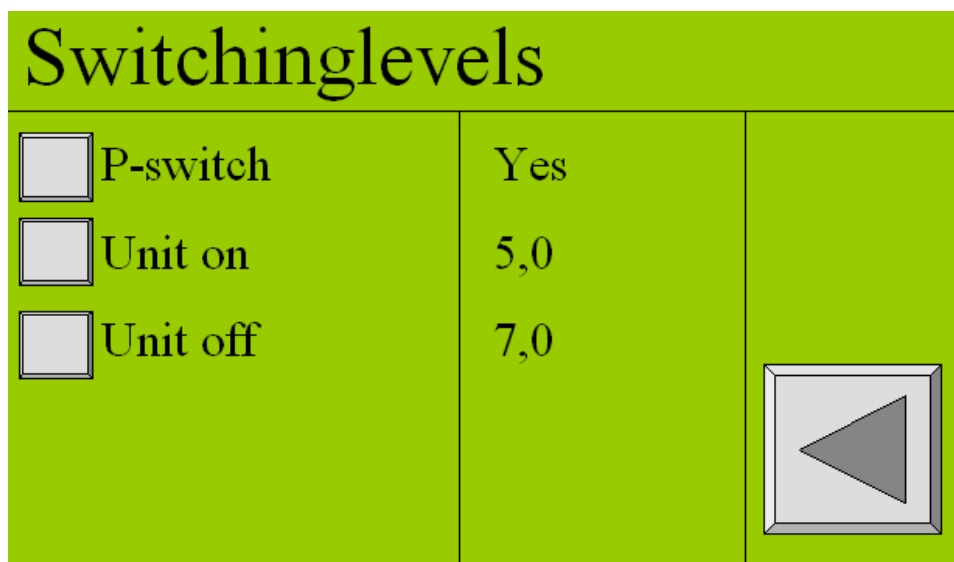

Button	Selection	Result
P-switch	Yes	Pressure switch is active
P-switch	No	Pressure switch is not active
Unit on	0-10 Bar*/ 0-145 PSI*	Pressure level at which the unit will switch on
Unit off	0-10 Bar*/ 0-145 PSI*	Pressure level at which the unit will switch off

\*refer to local settings menu 

To determine the correct switch on and off pressure, please check § 7.4.

### 6.3.4 Options menu

**Access:** Press option menu button  in settings screen (refer to §6.3)

**Function:** Set different options



**ATTENTION:**  
All options are default set to NO. Options do not affect the output and purity.

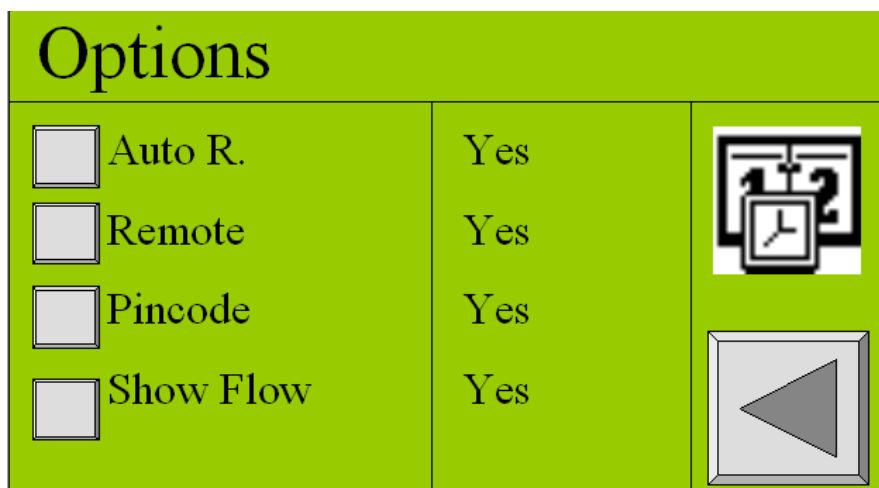

Button	Selection	Result
Auto R.	Yes	After a power failure the unit will automatically restart itself and return to the same situation/status.
Auto R.	No	After a power failure the unit will not start automatically. Unit needs to be restarted manually.
Remote	Yes	Unit can be switch on and off from a remote location. Only select <b>Yes</b> after connecting the printed circuit board to an external device.
Remote	No	Unit cannot be controlled from a remote location.
Pincode	Yes	Settings are instantly protected with a pin code. Return to <b>log on menu</b>  and enter the <b>default pin code 1234</b> .

Pin code	No	Settings can be changed without a pin code
Pin code	Change	Pin code can be changed to a personal 4 digits code. <b>(In case you forget your personal code, consult your supplier)</b>
Show Flow	Yes	Flow rate will be displayed in main screen
Show Flow (D)	No	Flow rate will not be displayed.
		Operate to adjust date and time

### 6.3.5 Local settings menu

**Access:** Touch local settings menu button  in settings screen (refer to § 6.3)

**Function:** Set data to local requirements

Depending on the local situation it is possible to change the setting accordingly.

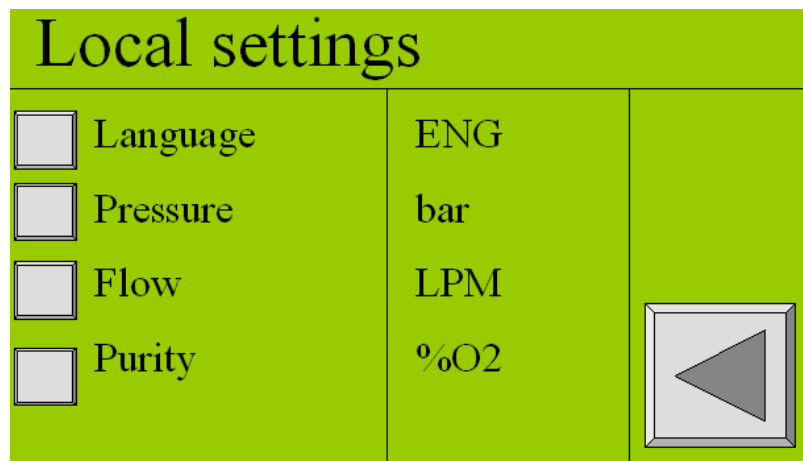

Button	Selection	Result
Language	English, Francais, Deutsch, Nederlands, Español	Text in the screen will appear in the chosen language.
Pressure	BAR/PSI*	Pressure indications will appear in the chosen setting
Flow	LPM/CFM	Flow will appear in the chosen setting
Purity	%N2/%O2	Purity will appear in nitrogen (%N2) or oxygen (%O2) percentage

\* Select BAR, to display temperature in °C. Select PSI to display temperature in °F.

### 6.3.6 Maintenance menu

**Access:** Touch maintenance menu button  in settings screen (refer to § 6.3)

**Function:** Shows maintenance status and offers calibration possibility.

The maintenance menu consists of 5 different screens. Each screen displays maintenance status or calibration buttons.

#### SCREEN 1/5

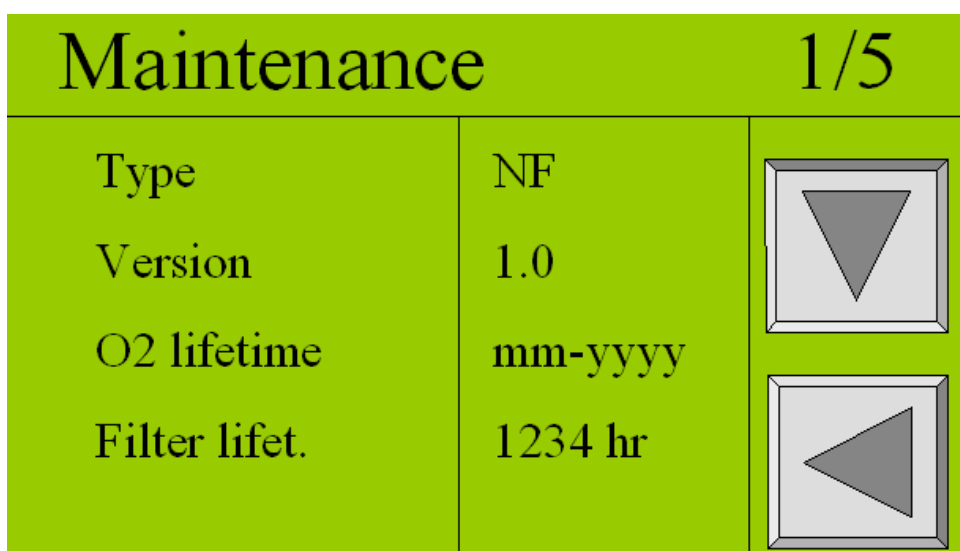

Data	Explanation
Type	Shows type of generator this unit is
Version	Software revision number
O2 lifetime	Month-year when O <sub>2</sub> -sensor needs to be changed (3 years from data of order)
Filter life	Hours countdown from 1 year to 0 hrs

**SCREEN 2/5**

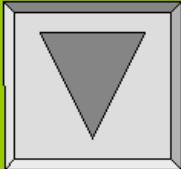
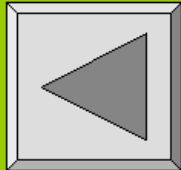
Maintenance		2/5
Total	0:00	
Comp. 1	0:00	
Comp. 2	0:00	

Data	Explanation
Total	Total running hours of the generator

**SCREEN 3/5**

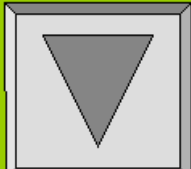
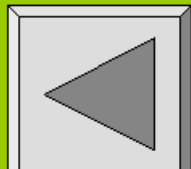
Maintenance			3/5
0.0	BAR	Outlet	
0.0	BAR	Inlet	
20	C	Inlet	
5	%O2		

Data	Explanation
Outlet	Outlet pressure in either BAR or PSI
Inlet	Inlet/compressor pressure in either BAR or PSI
C Inlet	Compressed air inlet temperature in °C or °F

**SCREEN 4/5**

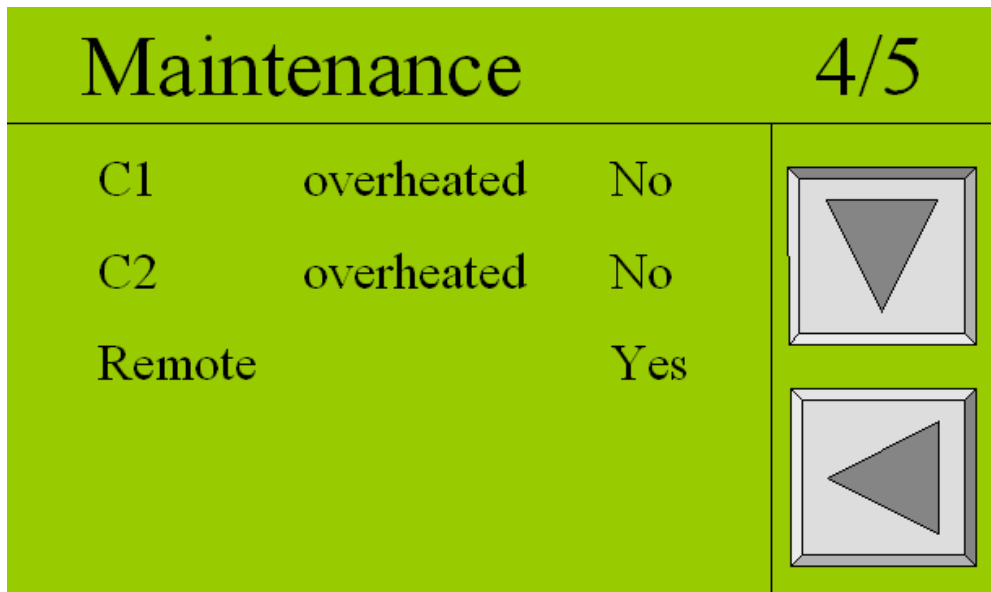

Data	Explanation
Remote	YES or NO Shows whether remote control option is on or off

**SCREEN 5/5**

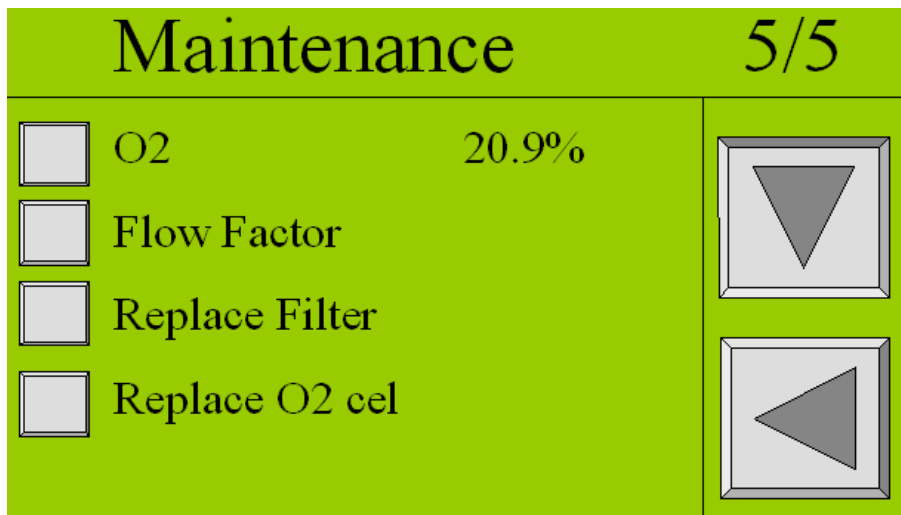

Button	Explanation
O2 – 20.9%	Calibrate O <sub>2</sub> sensor to 20.9% (refer to §9.4 for detailed explanation)
Flow Factor	Only visible when selected Show Flow in the options menu  (refer to §6.3.4) and when the unit is running.

	Calibrate the flow by entering the flow measured with an external flow meter.
Replace Filter	When a filter has been replaced during maintenance, this button can be touched and the countdown for the new filter is set. System asks for confirmation. In maintenance screen 1/5 the filter lifetime should read 5500 hr.
Replace O2 cell	When an O2 cell has been replaced during maintenance, this button can be touched and a new date to replace the O2 cell is set. System asks for confirmation. In maintenance screen 1/5 the O2 lifetime should read 3 year ahead from date of changing.

### 6.3.7 Data logging menu

**Access:** Press data logging menu button  in settings screen (refer to § 6.3)

**Function:** Read the logged (saved) data

Alarms as well as status of the sensors are saved on the SD-card. The time between the logging (saving) of this data to the memory card can be chosen in the data-logging menu.

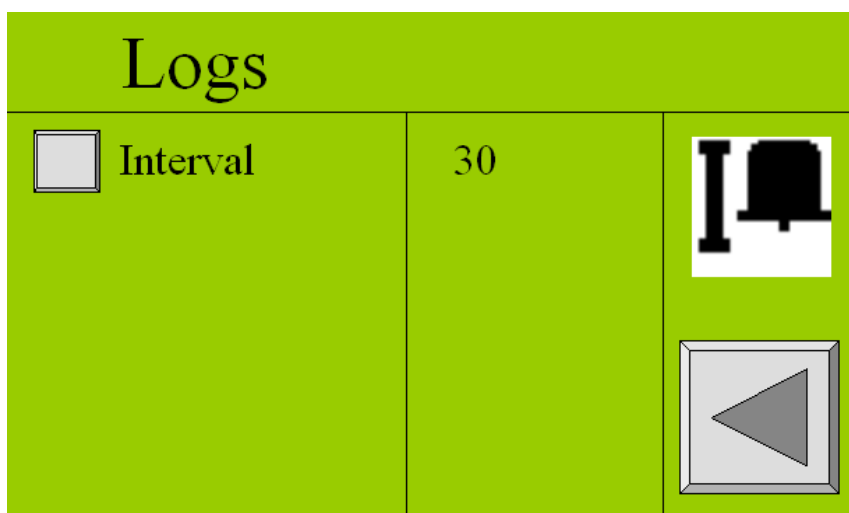

Button	Selection	Result
Interval	30-3600	Time in seconds between the logging (saving) of alarm data

	Shows all the alarms that have been saved on the memory drive (see below)
---	---

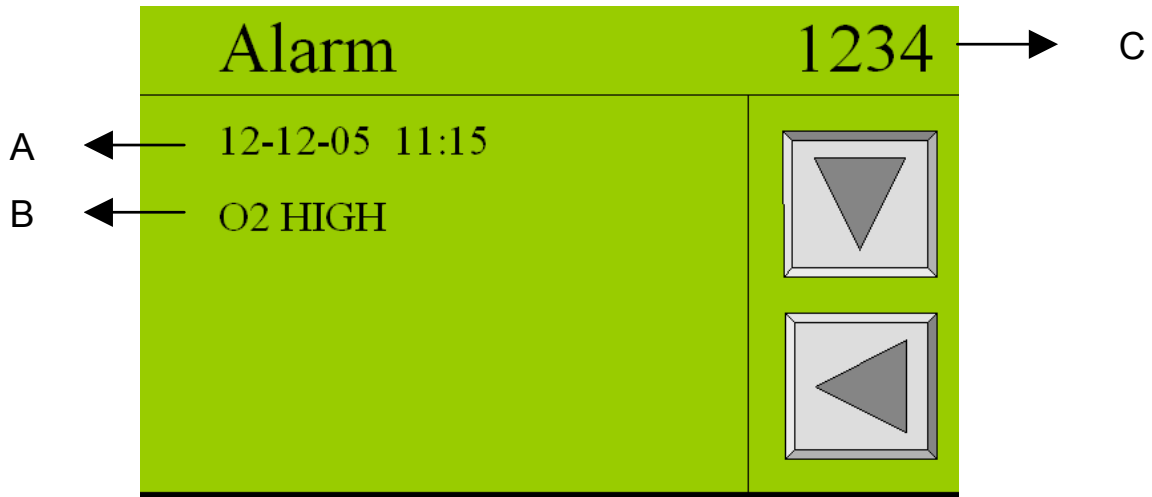

Button	Explanation
A	Date and time of alarm incident
B	Alarm description
C	The number of logged alarms

It is also possible to read the logged data from the SD-card on a computer. To read the files:

1. Switch off the unit.
2. Remove the SD-card
3. A new folder is saved on the SD-card every month. Each folder contains a almxxxx.csv and a logxxx.csv file.
4. Select the files needed.
5. Open the data-files with an Excel spread sheet
6. Place the SD-card back in the unit.
7. Switch the unit back on.



**CAUTION:**

**Please check the alarm, p-switch, options and settings before you restart the unit.**

**The unit cannot run without the SD-card. This will generate an alarm (SD-card failed).**

## 7 Operation

### 7.1 Commisioning NitroFlow<sup>®</sup> Lab

1. Make sure that the connections are correct and fixed properly.
2. Switch on the NitroFlow<sup>®</sup> Lab with the switch at the back of the generator (refer to §3.3).
3. Then touch the ON/OFF button  on the touch screen display in the front of the generator.



#### **CAUTION**

**Don't use sharp objects to operate the screen.**

4. It will take about 3 minutes before the NitroFlow<sup>®</sup> Lab will start to run. The countdown in seconds is shown on the display.



#### **IMPORTANT**

**The NitroFlow<sup>®</sup> Lab must be run with sheet metal covers mounted on the unit; not doing so will affect the heat management of the system and shut down the compressors; prolonged running without sheet metal covers will shorten the life of the appliance and can lead to irreparable damage**

5. Check the inlet pressure level in the maintenance -menu (screen 3/5); in case this exceeds a level of 4.5 bar(g), the unit must be switched off and checked for blockades on the outlet. When a cause cannot be found, stop running the system and contact your supplier.
6. Check whether the connections of the tubing between the NitroFlow<sup>®</sup> Lab and the application are free of leaks.
7. When the outlet is blocked the delivery pressure must not be higher than 8 bar(g); the excess nitrogen is vented via an internal pressure relief valve or the unit is switched off in case of no nitrogen demand.

8. The purity of the NitroFlow Lab is factory set as required. To adjust the oxygen content, adjust the purity control valve FCV. Refer to §7.3 for instructions.
9. The pressure control of the NitroFlow Lab is factory set as required. Two modes of pressure control are possible.
  - Switching on and off depending on the outlet pressure, max. switch-off pressure = 8.0 bar(g).
  - Continuous operation; excess produced nitrogen is vented. Maximum nitrogen pressure 8.0 bar(g). Refer to §7.4 for instructions.

## 7.2 Start NitroFlow<sup>®</sup> Lab

1. Move the switch on the back of the NitroFlow Lab to the ON-position (up).
2. Press on the NitroFlow<sup>®</sup> Lab with the ON/OFF button on the touch screen panel (refer to §6.2).
3. There is a 3 minute delay between stop and restarting the generator.
4. The NitroFlow<sup>®</sup> Lab will deliver nitrogen instantaneously.

## 7.3 Adjusting the purity

The purity of the output can be read on the main screen.

1. The purity is determined by measuring the residual oxygen content in the nitrogen outlet.
2. To change the purity, change the setting of the purity adjustment valve (refer to § 3.3) (left valve behind removable upper front panel)
3. First unlock the needle valve by loosening the hexagonal lock nut on its spindle. (Fig. 7-1)
4. Turning the valve clockwise will result in a decrease of the oxygen level and vice versa. The

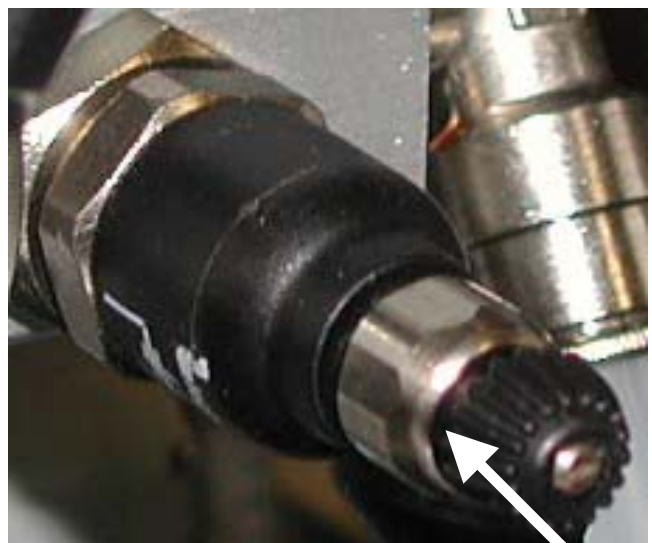

Fig. 7-1 Purity-adjustment-valve

oxygen level can be read on the main screen of the display.



**ATTENTION**

**The response time of the measurement is slow. Change the flow in small steps of a quarter turn per step and wait until the display reading changes.**

**Do not close the flow control valve fully.**

**Adjusting the purity must preferably be done when the system is at normal operating temperature after it has run for some time (1-2 hrs)**

**Adjusting the purity must be done while all sheet metal is mounted on the appliance**

5. Once the desired purity has been reached, fasten the lock not on the spindle of the purity control valve securely. Make sure you do not change the setting.



**ATTENTION**

**Fastening the lock nut too tightly can have an influence on the purity of the output**

## 7.4 Control of the outlet pressure

The outlet pressure of the NitroFlow<sup>®</sup> Lab can be controlled as follows.

Excess nitrogen will be vented; NitroFlow<sup>®</sup> Lab will run continuously. The -function must be **off**.

- Close the ball valve V2 (refer to §3.3) at the outlet while the system is running.
- Remove the right side panel
- Remove locking screw in knob of PCV;
- Pull the knob of the back pressure valve PCV out and turn it such that the outlet pressure on the touch screen reads 8.0 bar(g)/116 psig at maximum. The lower the pressure is set the better for energy consumption reasons and compressor life.
- Push the knob of the back pressure valve PCV and lock it with the crew
- Open the ball valve V2 at the outlet.

## 7.5 Stop NitroFlow<sup>®</sup> Lab

1. Press the ON/OFF button to switch the unit OFF (in case it is operating).
2. Switch off the power switch before you perform maintenance.
3. Make sure the system is depressurized; check the internal pressure level in the maintenance menu  (screen 3/5)
4. When you restart afterwards there is a 3 minutes delay before it starts again.

## 8 Troubleshooting

### 8.1 Error list

Error	Possible cause	Possible solution
No start and no display	Main switch is off	Switch main ON and push power switch ON.
	No power to supply outlet	Check electrical panel circuit breaker.
Delivery of nitrogen too low or absent	Ambient temperature is too high	Lower the temperature, if possible Check whether the minimum clearance between the NitroFlow <sup>®</sup> Lab and the walls is large enough.
	Inlet carbon adsorber filter is polluted	Replace the inlet filter
	NitroFlow <sup>®</sup> Lab is switched off	Switch on the NitroFlow <sup>®</sup> Lab
	Leak in piping	Check for leaks in the piping.
	Nitrogen outlet line is blocked.	Check/open the outlet line
	Temperature is too high	<ul style="list-style-type: none"> <li>• Ambient temperature is too high (over 35°C/ 95°F).</li> <li>• In-/outlet gratings are clogged.</li> <li>• Cooling fans are not or insufficiently functioning.</li> <li>• Compressors are overloaded.</li> </ul>
Residual oxygen content too high	Pressure in nitrogen storage vessel over 8 bar(g) because of erroneous setting of pressure switch	Reset pressure switch levels
	Ambient temperature lower than normal	Increase temperature or readjust purity (refer to §7.3)

Error	Possible cause	Possible solution
	Purity setting has changed over time	Readjust purity (refer to §7.3)
	Leak in piping	Check for leaks in the piping.
Generator shuts down and goes to stand-by	Reached pressure limit setting, if option activated	Reset pressure switch limits or deactivate option (refer to §6.3.3)
Display message with audible alarm	Outside of preset parameter limits	Refer to § 8.2

Table 8-1: Error list

## 8.2 Alarm messages

When the Nitrogen Out symbol (A)  in the main screen is flashing, it means that an alarm is occurring. To see which alarm is occurring, touch the symbol for more information.

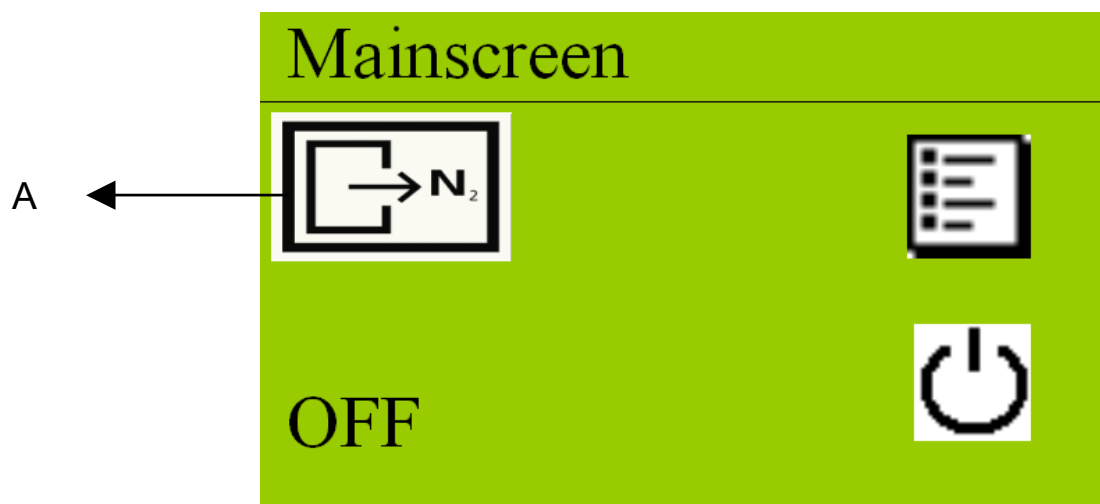

**Default all alarms that can be set, are set to NO. This means they are not activated**

What happens	Alarm description	Default
Oxygen level too high	O2 high	Off

Oxygen level too low	O2 low	Off
Inlet pressure too high	P-inlet high	Off
Inlet pressure too low	P-inlet low	Off
Outlet pressure too high	P-outlet high	Off
Outlet pressure too low	P-outlet low	Off
Inlet temperature too high	T-inlet high	On
Inlet temperature too low	T-inlet low	On
Membrane pressure sensor fails	P-mem sensor fail	On
Outlet pressure sensor fails	P-Outlet sensor fail	On
Inlet temperature sensor fails	T-Inlet sensor fail	On
Status of temperature of compressor box 1	Temp comp1	On
Status of temperature of compressor box 2	Temp comp2	On
Oxygen sensor needs to be calibrated	Calibrate O2 cel	On

When an alarm is displayed there are two options:

1. Accept
2. Reset

When **ACCEPT** is touched, the alarm sound will disappear while the alarm level is still exceeded. If the alarm is not resolved the alarm message will appear again in 24 hours. This function gives you some time to work on the solution.

When **RESET** is touched the alarm status is cleared. However, if the alarm still exist it will appear again after the delay time that has been entered in the alarm settings menu  (refer to § 6.3.2) has passed.

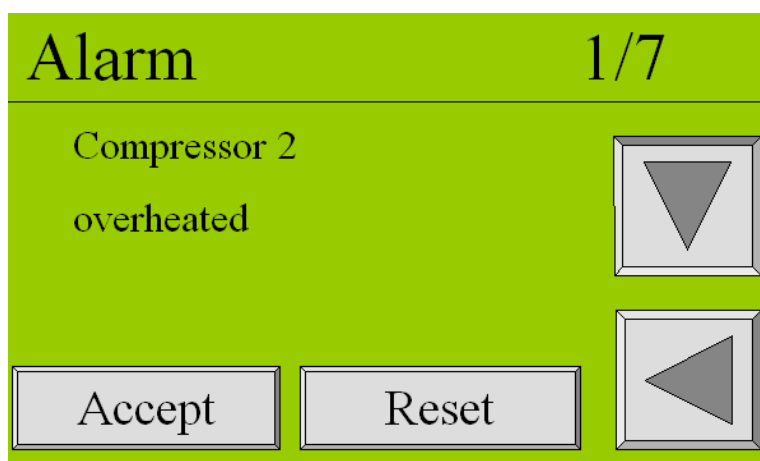

## 9 Maintenance

### 9.1 Maintenance schedule

Part	Action	Frequency
Filters	Replace outlet carbon adsorber	<ul style="list-style-type: none"> <li>• 1x per year</li> </ul>
Oxygen sensor	Replace oxygen sensor	<ul style="list-style-type: none"> <li>• 1x per 3 years</li> </ul>
Oxygen sensor	Calibrate oxygen sensor	<ul style="list-style-type: none"> <li>• 1x per year</li> </ul>
Air compressor (LP/LP)	Replace on failure	<ul style="list-style-type: none"> <li>• expected life &gt;&gt;8000 hrs</li> </ul>
Nitrogen compressor (LP/HP)	Replace on failure	<ul style="list-style-type: none"> <li>• expected life &gt;8000 hrs</li> </ul>
Battery on PCB	Replace on failure	<ul style="list-style-type: none"> <li>• expected life &gt;5 years</li> </ul>

Table 9-1: Maintenance schedule

### 9.2 Replace inlet filter element

1. Switch off the NitroFlow® Lab.
2. Let the system depressurize.
3. Take off the upper part of the front panel of the NitroFlow Lab (refer to Fig. 9-1). No tools are required.
4. Unscrew the two screws on top of the front panel (refer to Fig. 9-2).



Fig. 9-1



Fig. 9-2

5. Open the front panel (refer to Fig. 9-3).
6. Disconnect the plug from the printed circuitboard (refer to Fig. 9-4).



Fig. 9-3



Fig. 9-4

7. Disconnect the tubing from the inlet filter (refer to Fig. 9-5).
8. Loosen the screws of the brackets (refer to Fig. 9-6).



Fig. 9-5



Fig. 9-6

9. Slide out the inlet filter and replace it with the new one. Follow the steps in reverse order.
10. Switch the NitroFlow<sup>®</sup> Lab back on.

### 9.3 Replace oxygen sensor

1. Switch off the NitroFlow<sup>®</sup> Lab.
2. Remove the front cover above the touch screen from the NitroFlow<sup>®</sup> Lab (no tools required)(refer to Fig. 9-1).
3. Carefully remove the sensor cap (E). Do not pull the tube.
4. Unscrew the screw ring (D).
5. Disconnect connector (A).
6. Install the new sensor (C).
7. Switch on the NitroFlow<sup>®</sup> Lab.
8. Calibrate the oxygen sensor. Refer to §9.4

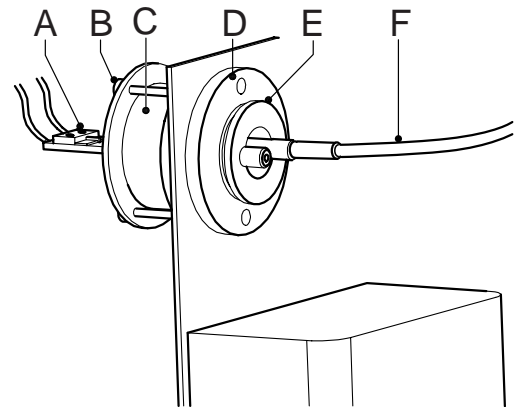



Fig. 9-7: Replace oxygen sensor

### 9.4 Calibrate oxygen sensor

1. Switch the unit off by touching the front **switch off** button  (refer to §6.2).
2. Let the system depressurize
3. Remove the sensor cap (E) and expose the sensor to ambient air.
4. Wait for 60 seconds.

**Caution:**



**The sample flow is factory preset by with FCV3 and normally should not be adjusted. Tampering with this valve will have a major affect on the operation of the generator.**

5. If the sample flow needs to be verified, connect a low flow meter coming out of tube (F) and measure flow rate. Flow Rate should be 300 cc/minute. If Flow Rate needs to be adjusted, unlock the locking nut and turn black adjustment knob of the Sample Flow Valve (FCV3). Counter clockwise increases the flow, clockwise decreases the flow. Note: This is a very sensitive adjustment, turn

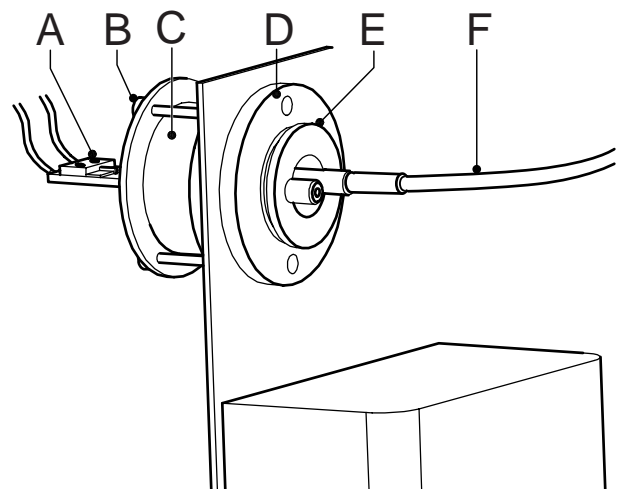



Fig. 9-8: Calibrate oxygen sensor

in small increments and wait for the resulting change before readjusting.

**Tip:**



**In the absence of a flowmeter one can determine the flow by adjusting it such that it is barely felt when you hold the outlet of the tube close to a wet finger tip; excessive flow must be prevented**

6. Then enter again the maintenance menu , screen 3/5 wait until the oxygen level reads 20.9%.
7. Then go to screen 5/5 and touch O2 20.9% button. The system will ask for confirmation. Select **YES**.

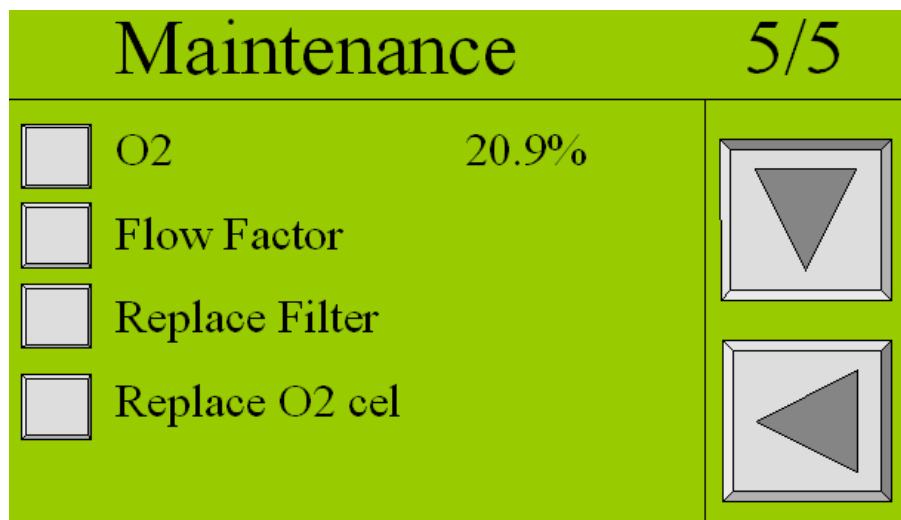

8. Reconnect the tube (F) and the sensor cap (E) with the sensor (C).

## 9.5 Replace compressor

1. Switch off the NitroFlow<sup>®</sup> Lab.
2. Let the system depressurize.
3. Remove both left and right-side cover from the NitroFlow<sup>®</sup> Lab by taking the 2 screws from each side. (Fig.9-9)
4. Then remove the second cover from each side(Fig. 9-10).
5. Use a 19mm open-end wrench to undo all bull nose connections to the compressor. (Fig. 9-11).



Fig. 9-9 – unscrew side panels



Fig. 9-10 – remove second cover



Fig. 9-11 undo bull nose connections

6. Use a 13mm spanner to unscrew the four bolts holding the compressors to the unit on both sides.(Fig. 9-12)
7. Use a 10mm spanner to push the ring in with the plastic tube. Hold the spanner while pulling away the tube. (Fig. 9-13)
8. Use an 8mm spanner to push ring in with the pipe. Hold the spanner while pulling away the pipe (Fig. 9-14)



Fig. 9-12 – unscrew bolts from compressors



Fig. 9-13 – pull away pipe



Fig. 9-14 – pull away pipe

9. Disconnect the multi-pin plug from the socket by squeezing the clips on each side. (Fig. 9-15)
10. Lift and withdraw the compressor assembly from the unit (Fig. 9-16).

11. Remove the new compressor from its packaging. Remove the transit support blocks. (Fig. 9-17)



Fig. 9-15 – disconnect multi-pin plug



Fig. 9-16 – remove compressor



Fig. 9-17 – remove transit support blocks

12. Remove the pipe fitting, which can be disposed of. (It's only included for manufacturer's use). (Fig. 9-18)
13. Install the new compressor in reverse order of removal.
14. Retain compressor packaging to ship old compressor (if necessary).
15. Check for leaks before re-assembly.



Fig. 9-18 – remove pipefitting

## 9.6 Software updates

The issue number of the software version for the controller of the NitroFlow can be found in the maintenance -menu (refer to §6.3.6). When Parker Filtration & Separation would update the software in the future you can have full advantage of that. A new version can be put on the control system by following the instructions below.

1. Switch the unit off.
2. Allow the system to depressurize.
3. Remove the SD-card
4. Place the SD-card in a card reader connected to a computer
5. On the SD-card are 2 bin files: *io.bin* & *lcd.bin*. Just for safety you could save the old contents of the SD-card on your computer.
6. Replace the old files with new versions, which you receive from Parker.
7. Replace the SD-card in the control unit.
8. Switch the power back on.

9. Now the controller is updating, while beeping.
10. Turn the power off and on when the display shows “turn power off/on”.
11. Now the display is updating, while beeping.
12. Once the beeping stops the system is updated.

# 10 Electrical scheme

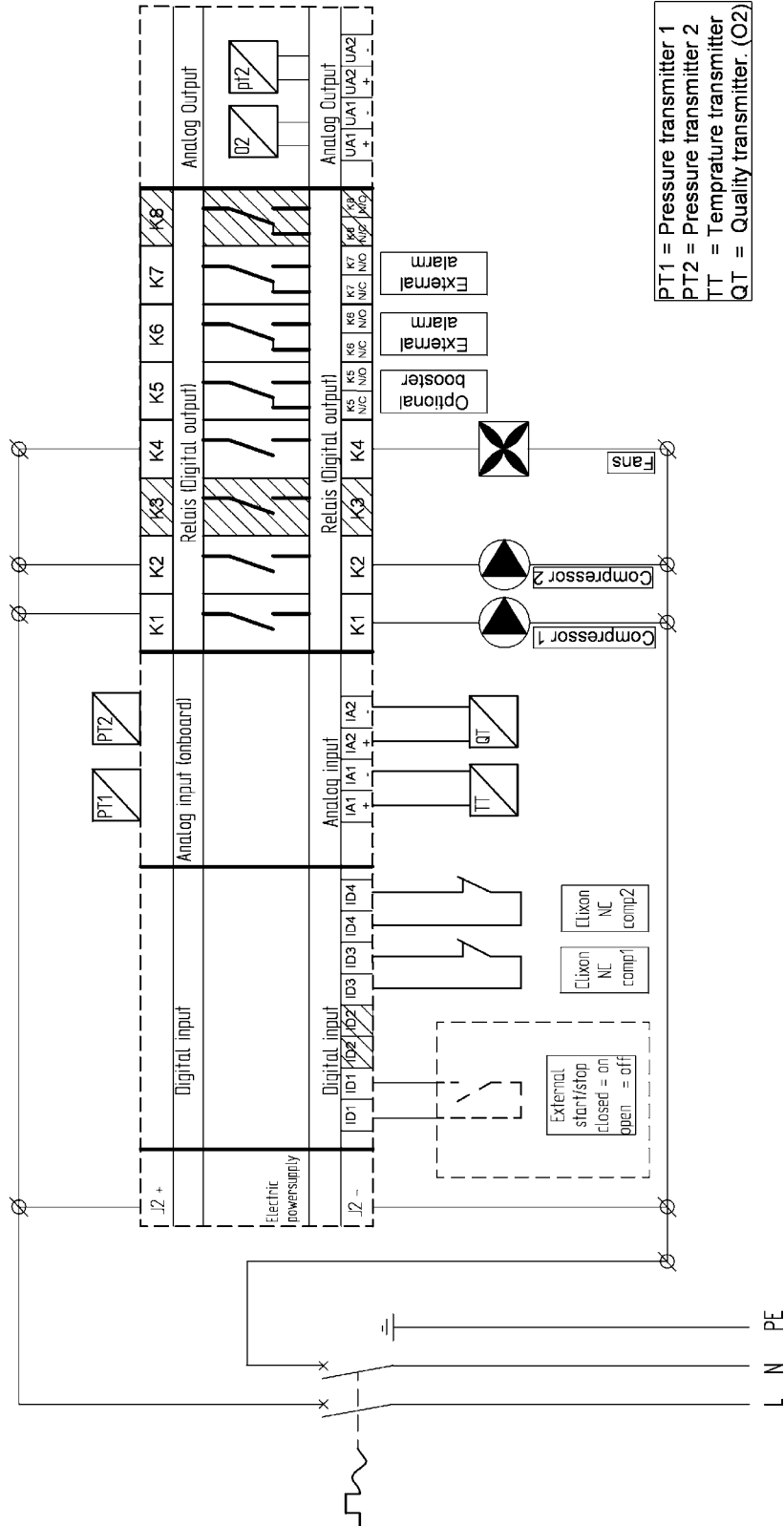

# 11 Index

Air quality .....	16	Maintenance .....	44
Alarm messages.....	42	Maintenance kit.....	19
Alarm settings menu.....	27	Maintenance menu .....	32
Ambient air .....	12	Net weight.....	16
Ambient conditions .....	16	Nitrogen .....	9
capacity .....	19	nitrogen consumer .....	21
Caution .....	6	Noise level .....	16
Certificates .....	7	outlet pressure .....	39
Check equipment .....	21	Oxygen .....	9
Connect power .....	21	Oxygen enriched air.....	9
Connections .....	16	Oxygen sensor	
Control panel.....	23	calibration.....	46
Data logging menu .....	35	Oxygen-enriched air .....	9
Default settings .....	17	Parts .....	14, 44
Delivery pressure .....	16	Pictograms.....	6
Dimensions .....	16	Power consumption .....	16
Electrical data.....	16	Pressure switch menu .....	29
Electrical scheme .....	50	Process scheme .....	15
Electricity.....	6, 10	relative humidity.....	16
Environment.....	6	Replace	
Environmental aspects.....	11	oxygen sensor.....	46
Error list.....	41	Risk of fire.....	6
High Pressure .....	16	Safety precautions .....	10
High-pressure risk .....	6	Separation principle .....	12
Identification plate .....	7	Settings menu .....	25
inlet filter.....	44	Technical specifications.....	16
Installation .....	20	Temperature .....	16
Introduction .....	5	Transport .....	20
Liability .....	8	Troubleshooting .....	41
Local settings menu .....	31	User instructions .....	8
Location.....	20	Voltage/frequency.....	16
Log on menu .....	26	Warning .....	6, 9, 10